



Technical Data

Specification & Capacities

JF545

OVERALL DIMENSIONS

(with jib and low marking pads)

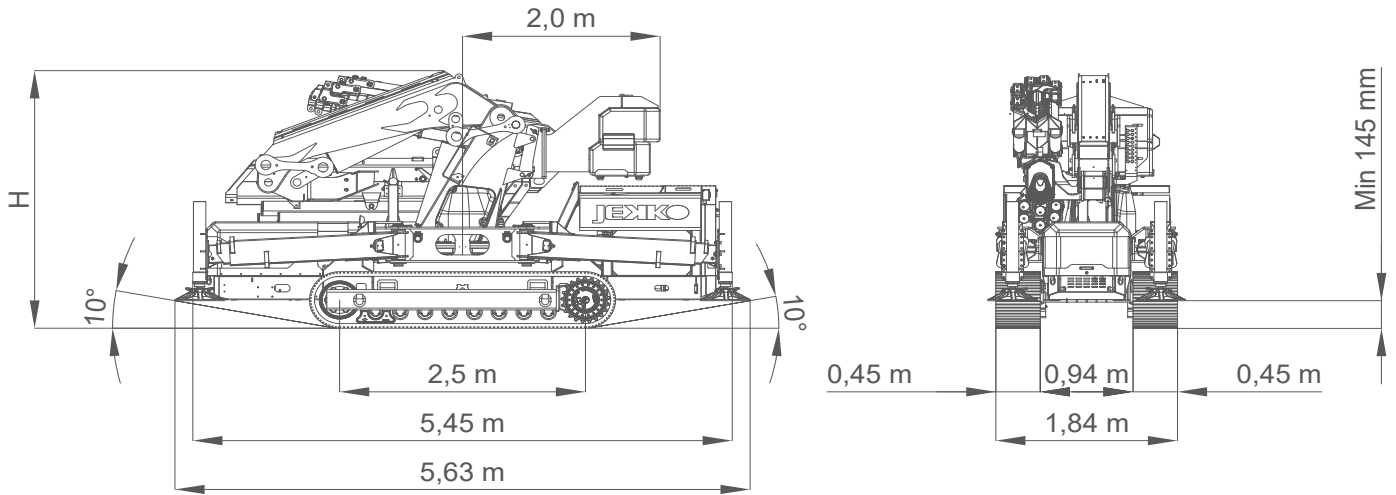

H=2,83 m with V20 winch / H=2,90 m with V30 winch

STABILIZATION AREA

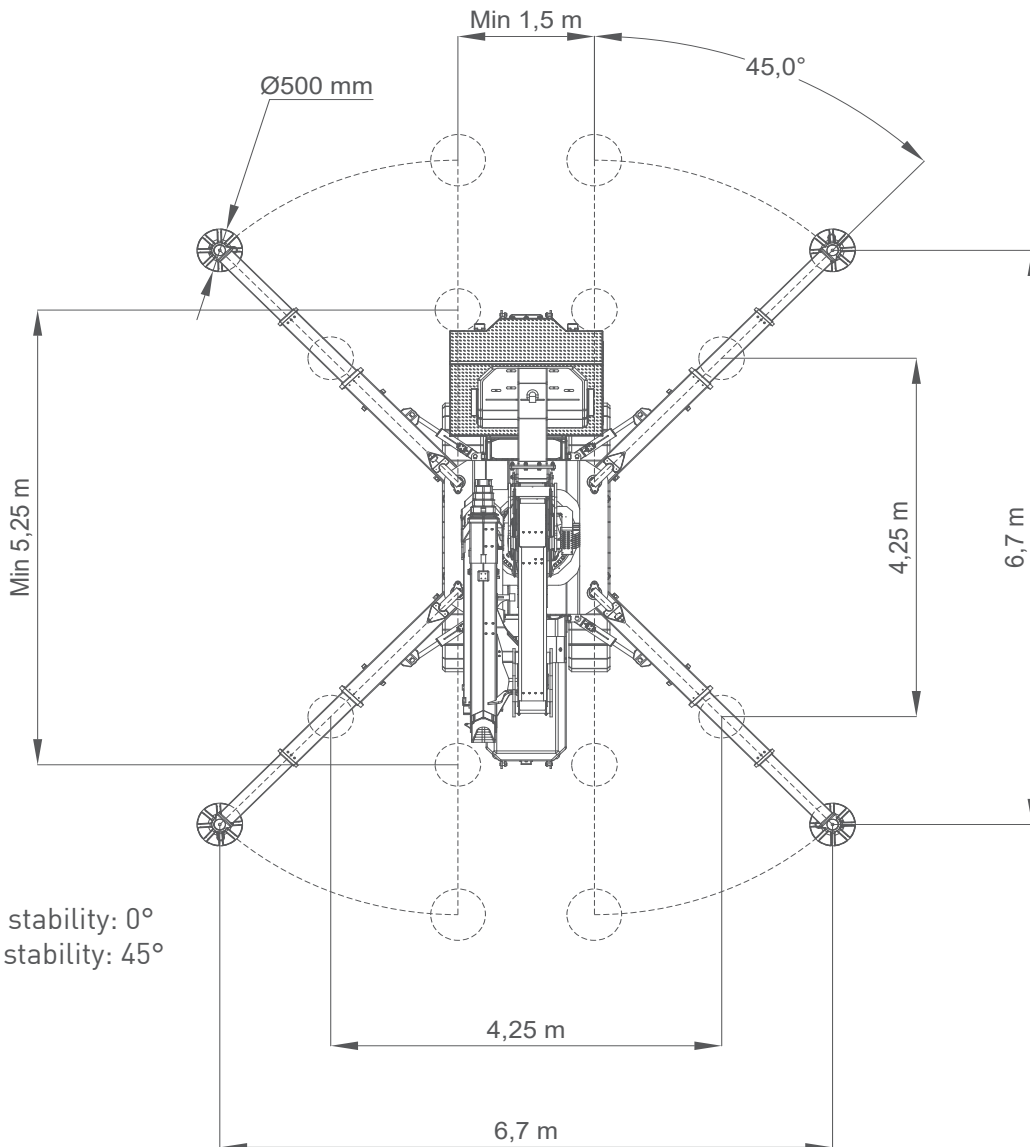

Min angle stability: 0°
Max angle stability: 45°

CRANE PERFORMANCE

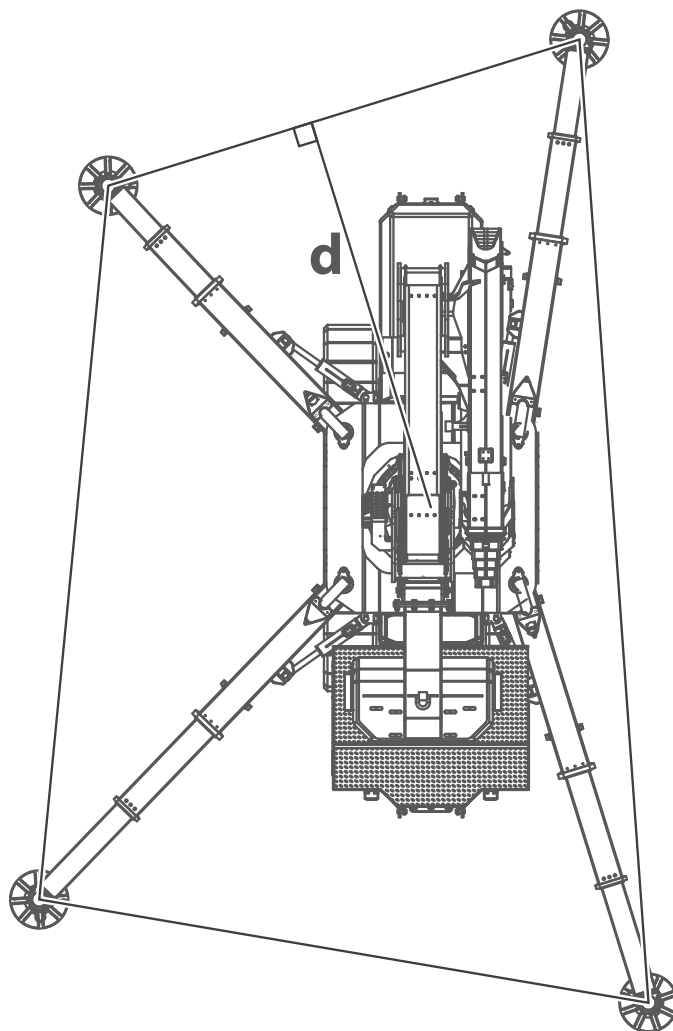

K	d min	d max
K1	1,6 m	2,0 m
K2	2,0 m	2,6 m
K3	2,6 m	3,1 m
K4	3,1 m	3,2 m
K5	3,2 m	-

STABILIZATION CHART

The division in 4 areas is a schematic representation, software adapts level pressure continuously.

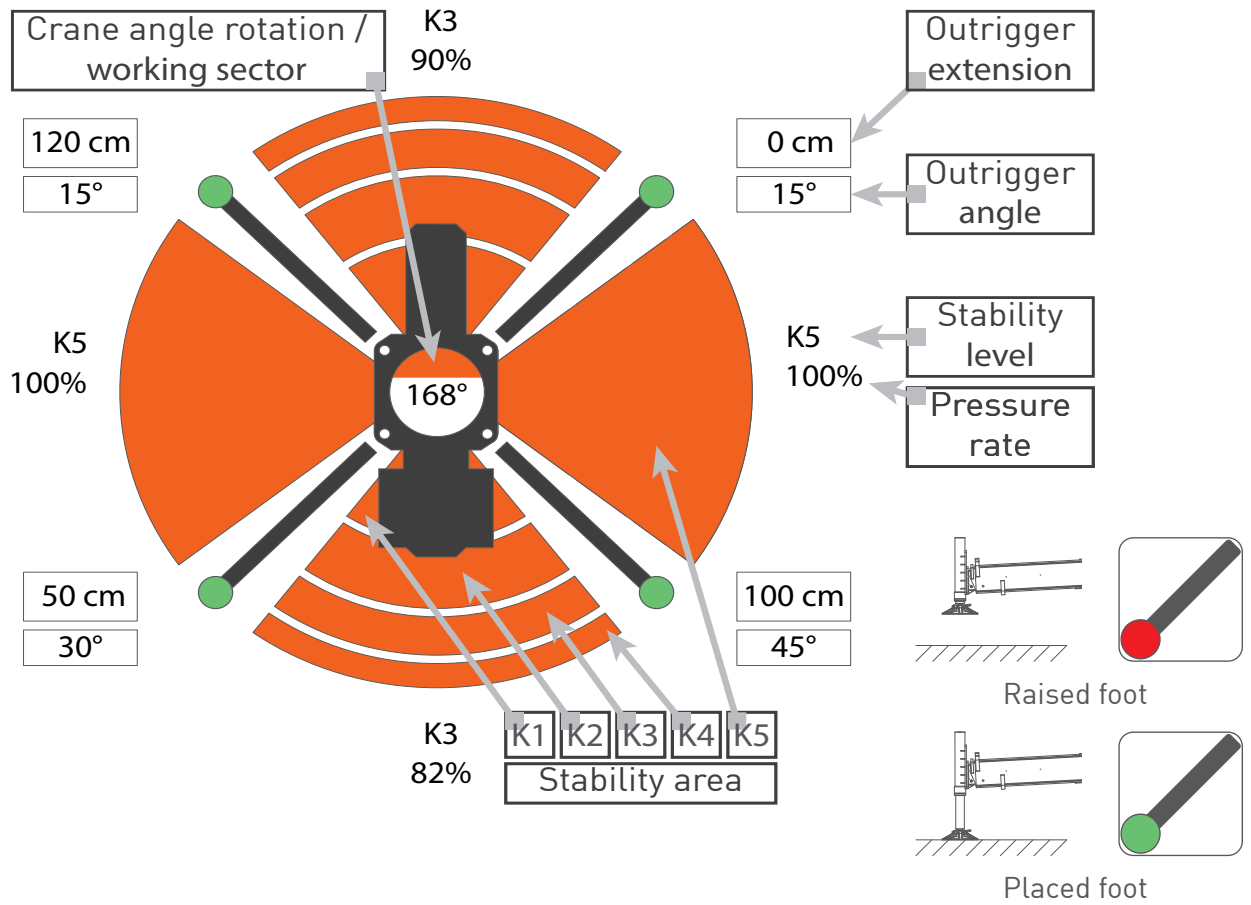

STABILIZATION ADJUSTMENT

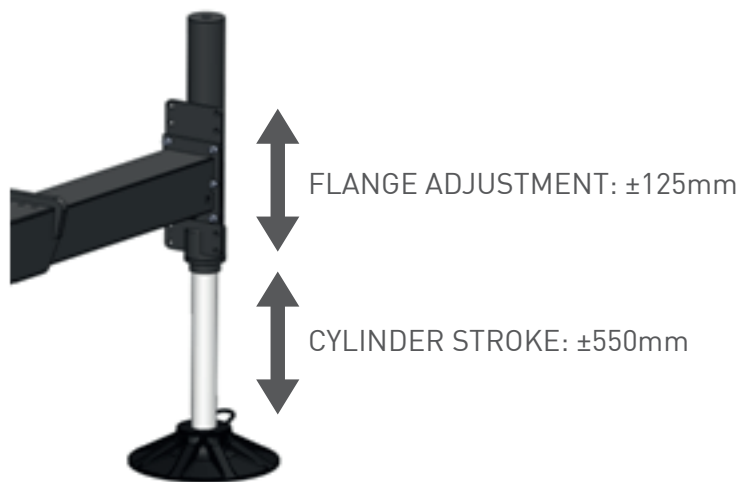
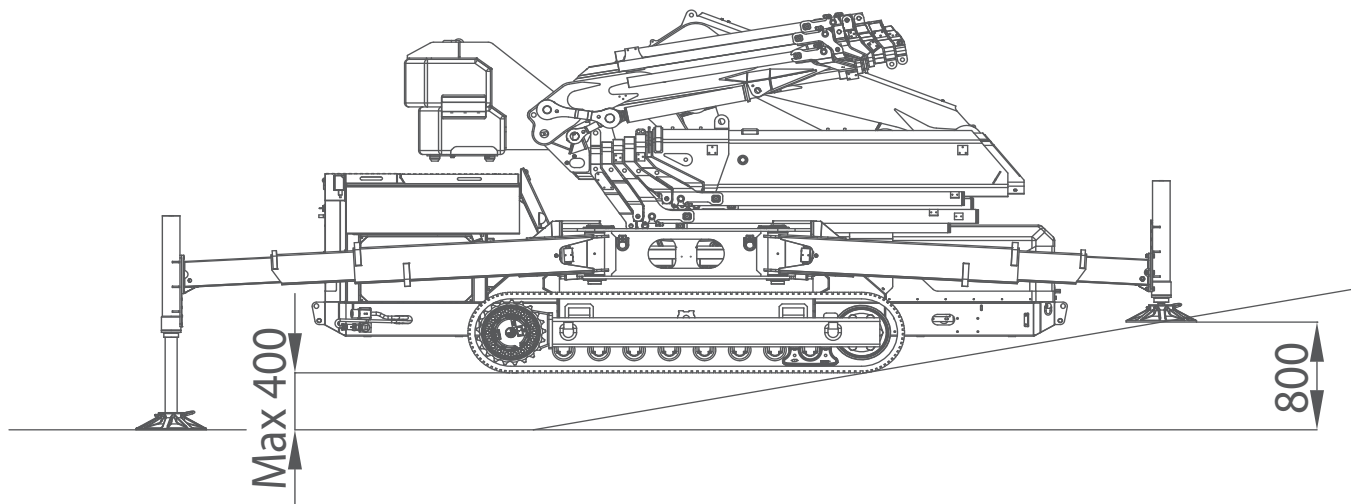

JF545 - MAIN BOOM

with HOOK

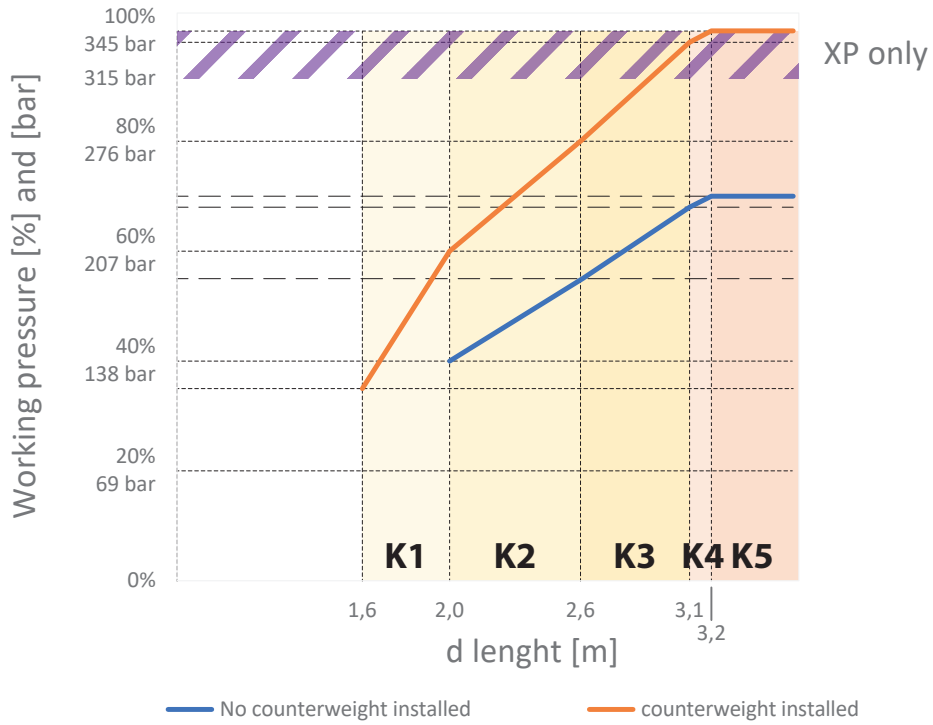

with WINCH

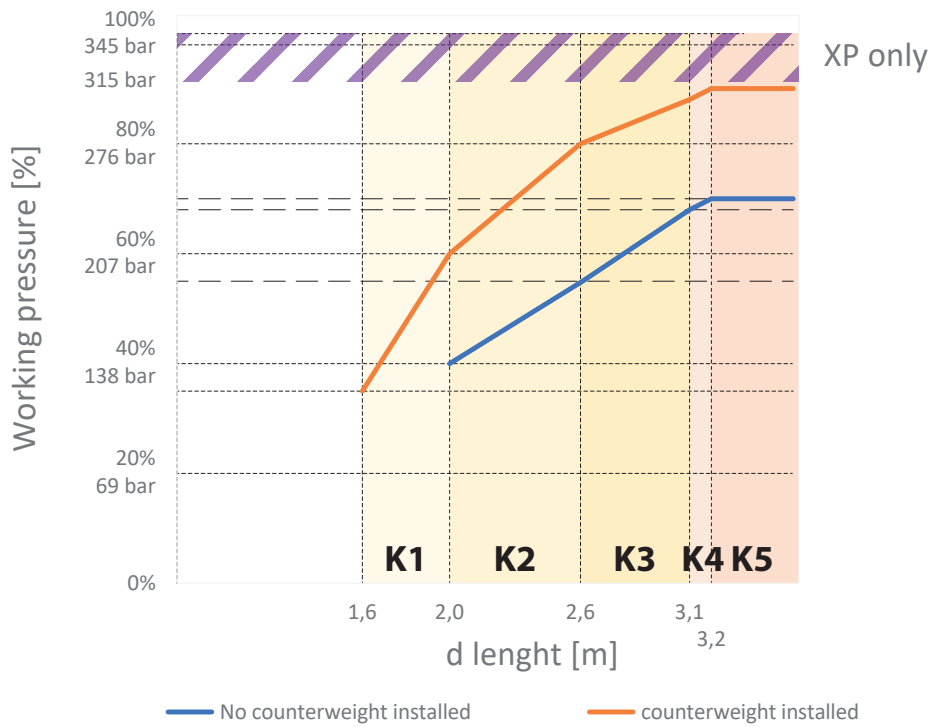

JF545 - JIB3000.6HA



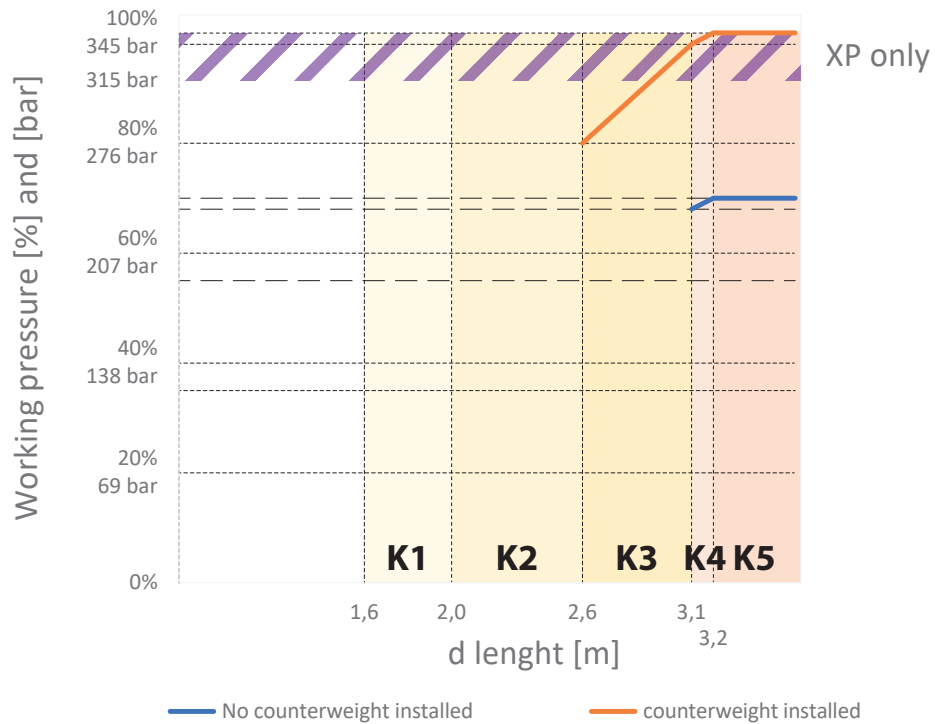

with HOOK

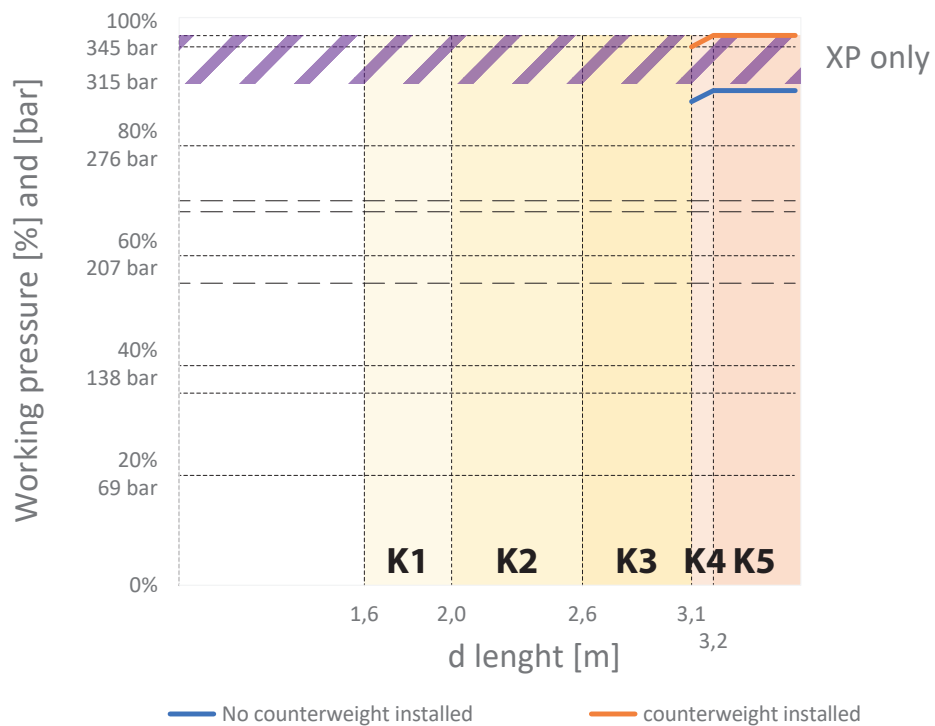











with WINCH



OVERALL INFORMATION

		Name/ version	kg*
WEIGHTS	 Crane	ALL	13500
	 Counterweight	ALL	3500
	Winch	W2000-JFM	200
		W3000-JFM	200
	 Hookblock	SINGLE FALL	47
		DOUBLE FALL	58
		TRIPLE FALL	57
		JIB SINGLE FALL	75
	 Power Pack	3-PHASE POWERPACK	80
		L426	1200
	 Jib	MEH-545.6	90
		ME1-545.6	95
		MEH-JIB3000.6HA	23
ME1-JIB3000.6HA		36	
Low marking pads		WTP-JFM	300 (3,25 x 92)
 Outriggers mats	OM500	30	

ENGINE	 Engine	KUBOTA V3307-CR-TE4B	
	KW Power	55,4kW 74HP	
	 Fuel	DIESEL	
	 Tank	L	75
ELECTRIC	KW Power	400V-3F 13kW 17,4HP	
HYDRAULIC	 Hydraulic Oil	ISO 6743-4:HVLP with VG46 viscosity class	
		Working temp	<70°C
		L	200
MOVEMENTS	 Travel Speed	km/h	1 / 2,2
	 Gradeability	20° (36%) [†]	
	 Track Load	kg/cm ²	0,85
	 Outrigger Load	kg	11250 [‡]
	 Working Angle	0°/80°	
		s	Primary: 37 Secondary: 39
	 Slewing	360°	
		rpm	1
 Boom Telescoping	m	28,2	
	s	42 [§]	

*: Dry weight

†: Engine working limit

‡: Static lifting

§: Timing without load, fully stabilised and without XP

HOIST PERFORMANCE

W2000-JFM				
WINCH	Layer	Max line pull	Standard rope speed	Highest rope speed
		kg	m/min	m/min
	1	2600*	36,5	N/A
	2	2400*	40,0	N/A
	3	2200*	43,5	N/A
4	2040*	47,0	N/A	
ROPE	Wire rope	Ø	Total length	Max load
		mm	m	kg
	Right lang lay	12	60	2400
HOOK BLOCK	Load	N° of		Block type
	kg	Sheaves	Lines	
	6000	1	3	Triple fall block
	3500	1	2	Double fall block
	2000	-	1	Single fall block

W3000-JFM				
WINCH	Layer	Max line pull	Standard rope speed	Highest rope speed
		kg	m/min	m/min
	1	3870†	45,0	N/A
	2	3565†	49,0	N/A
3	3260†	53,0	N/A	
ROPE	Wire rope	Ø	Total length	Max load
		mm	m	kg
	Right lang lay	14	60	2400
HOOK BLOCK	Load	N° of		Block type
	kg	Sheaves	Lines	
	6000	1	2	Double fall block
	3000	-	1	Single fall block

*: LMI limited at 2000 kg

†: LMI limited at 3000 kg

JF545 - MAIN BOOM

HOOK and FULL COUNTERWEIGHT installed

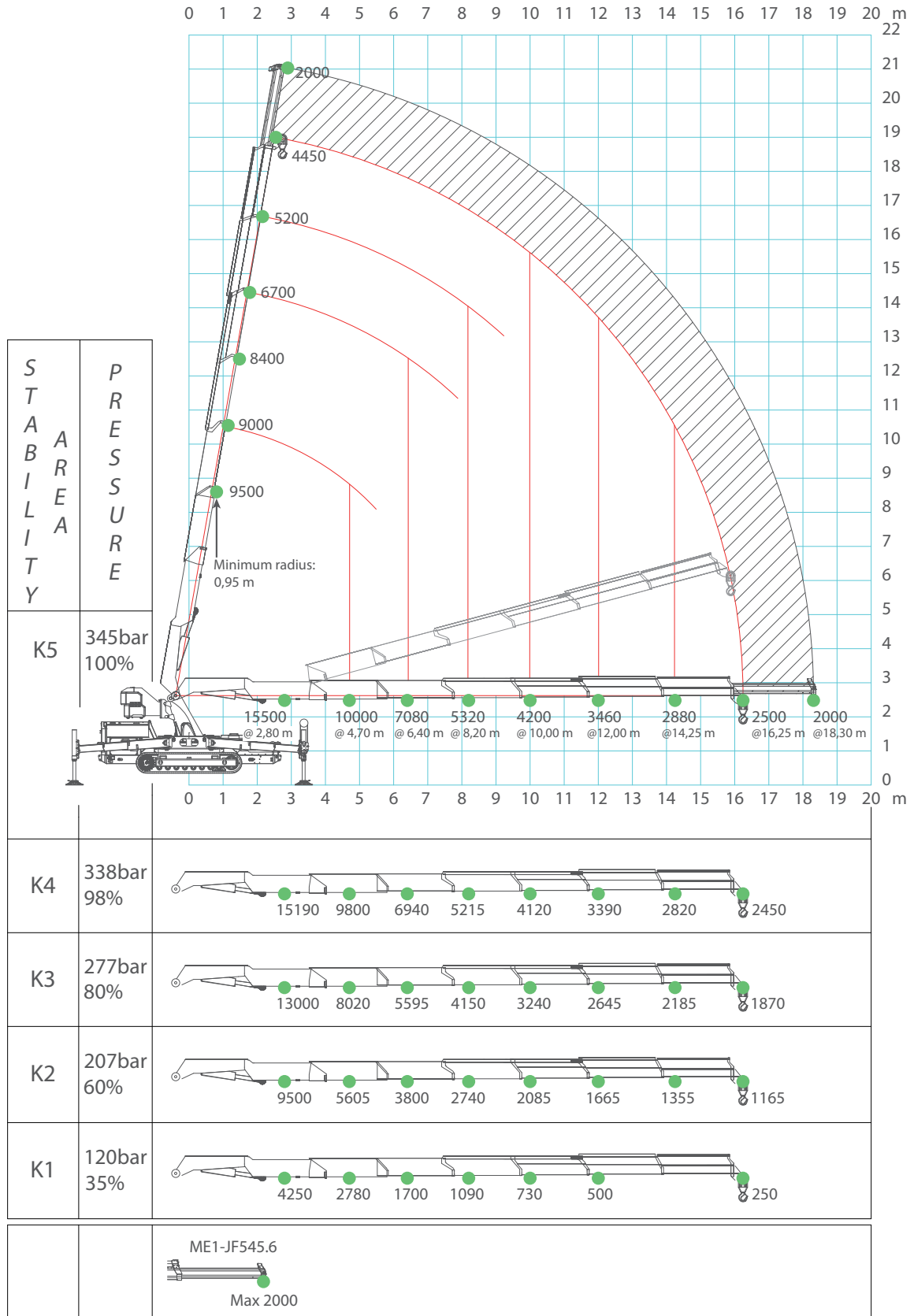

JF545 - MAIN BOOM

HOOK and NO COUNTERWEIGHT installed

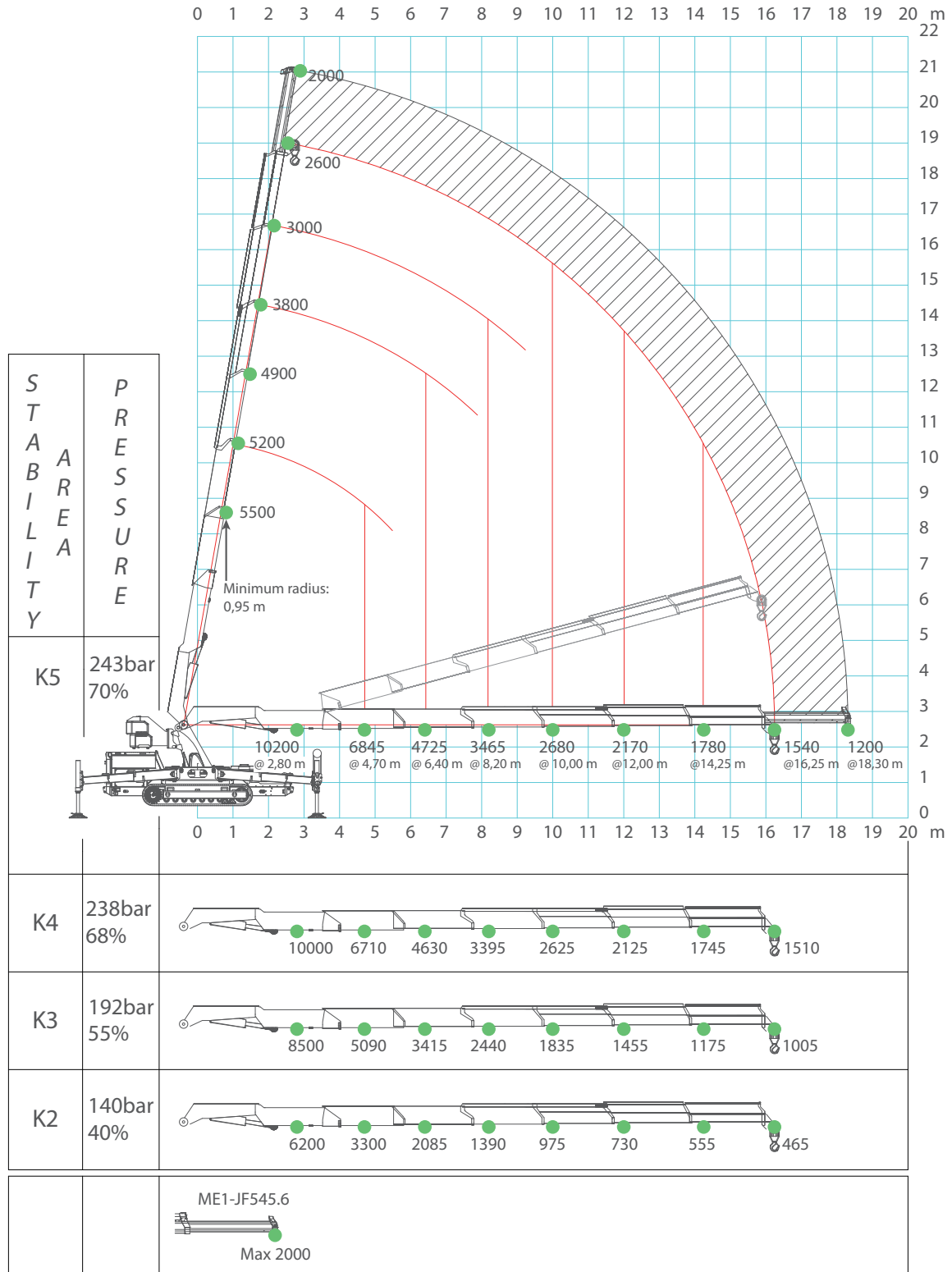

JF545 - MAIN BOOM

W2000-JFM and FULL COUNTERWEIGHT installed

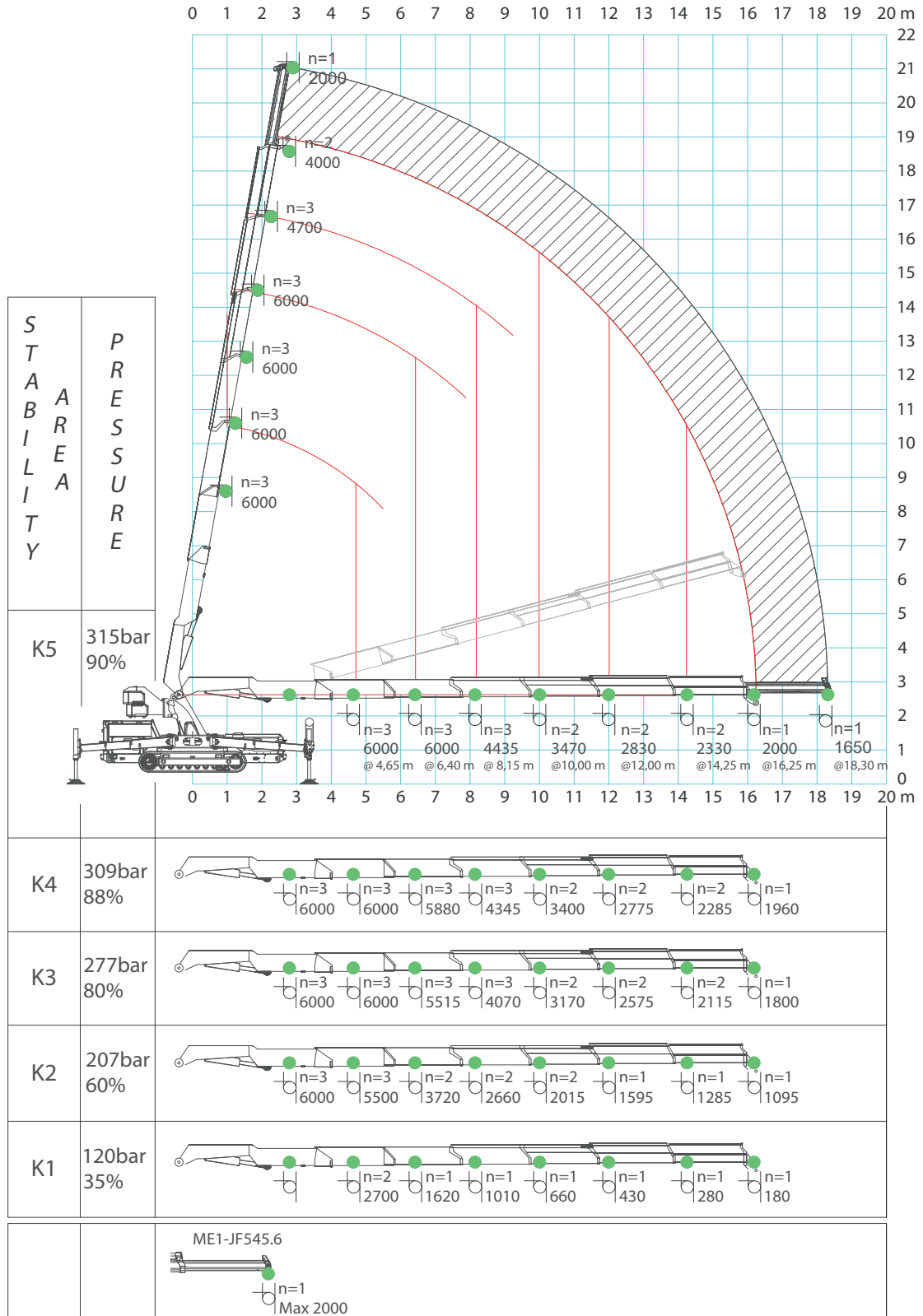

JF545 - MAIN BOOM

W2000-JFM and NO COUNTERWEIGHT installed

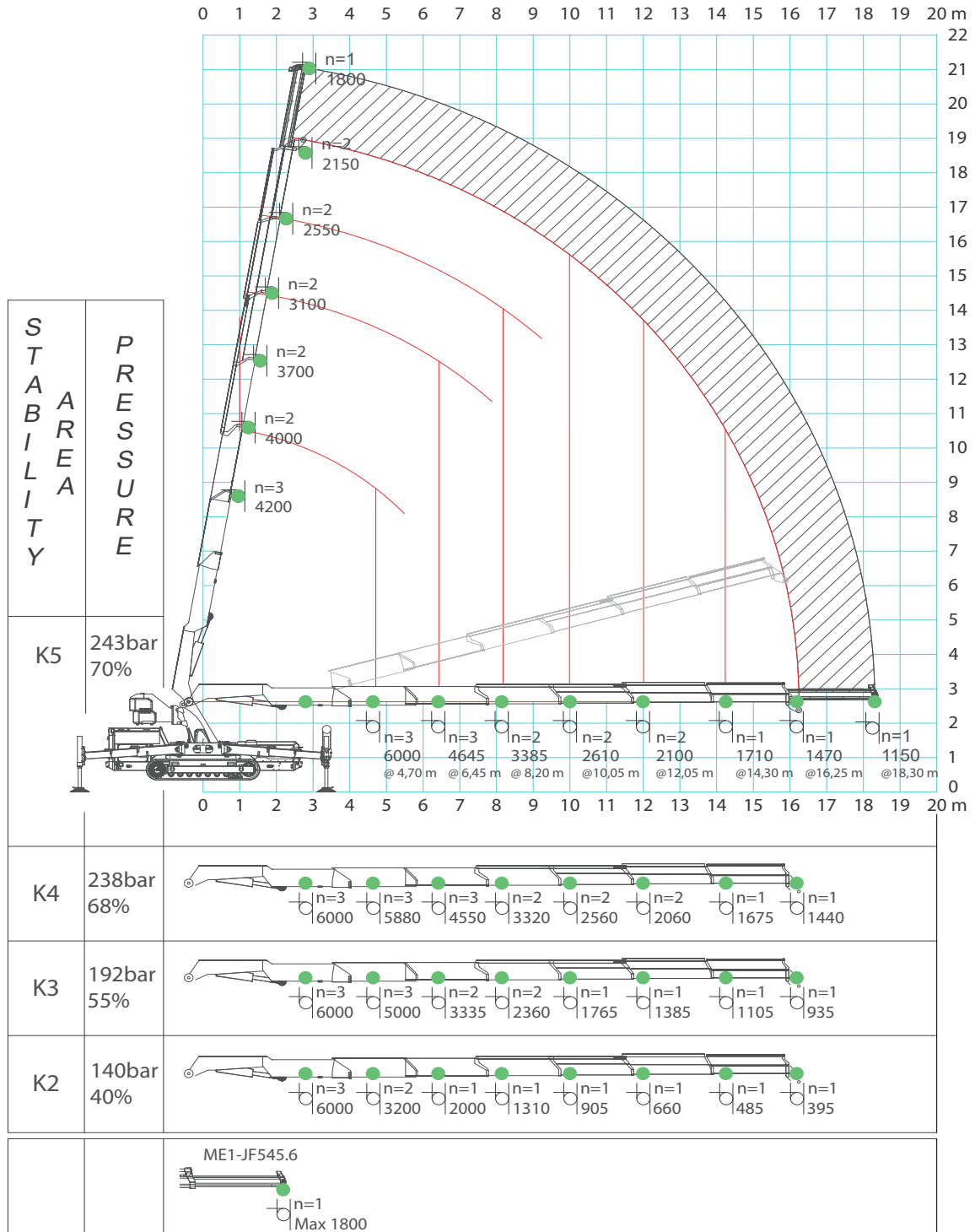

JF545 - JIB3000.6HA

HOOK and FULL COUNTERWEIGHT installed

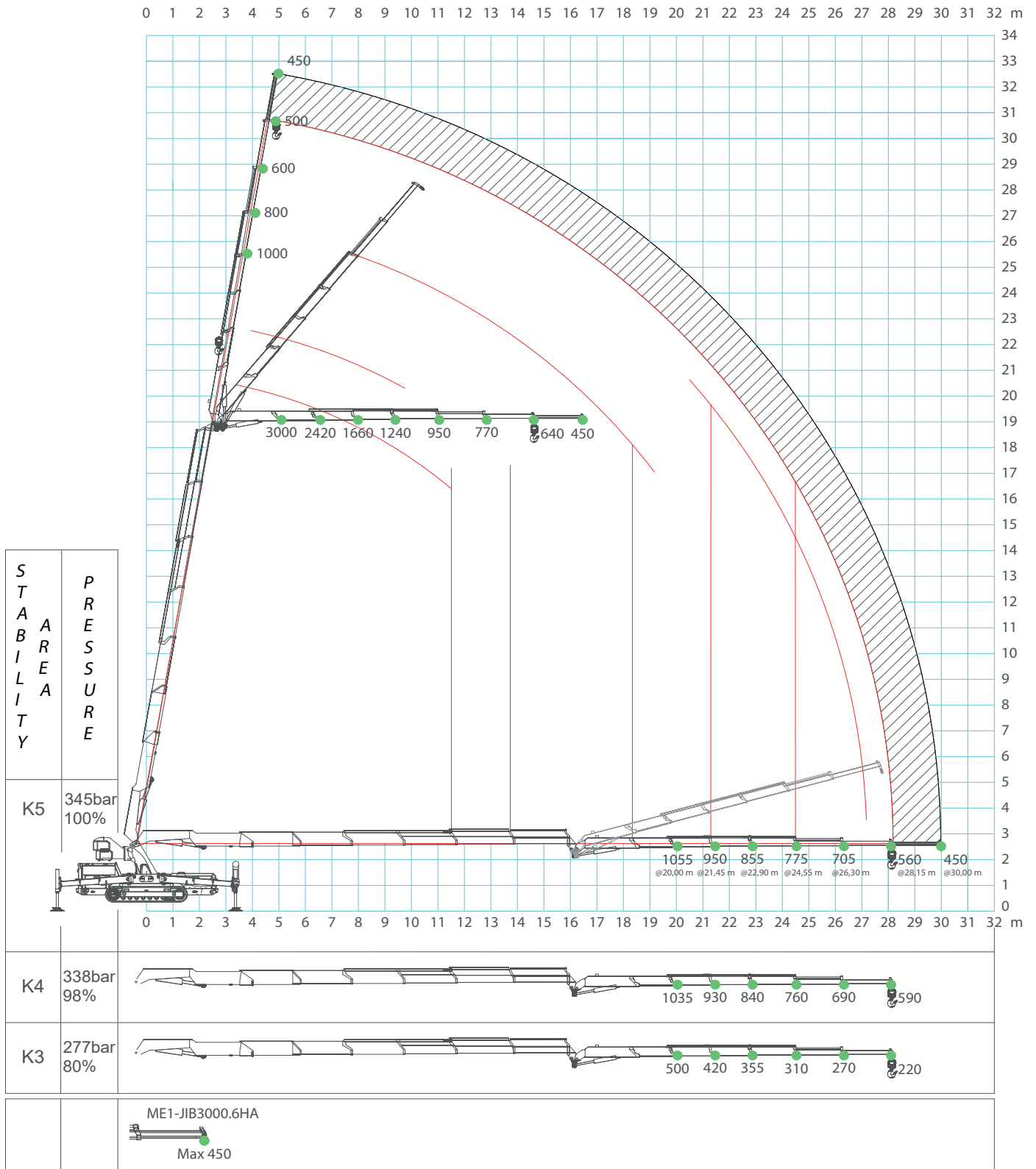

JF545 - JIB3000.6HA

HOOK and NO COUNTERWEIGHT installed

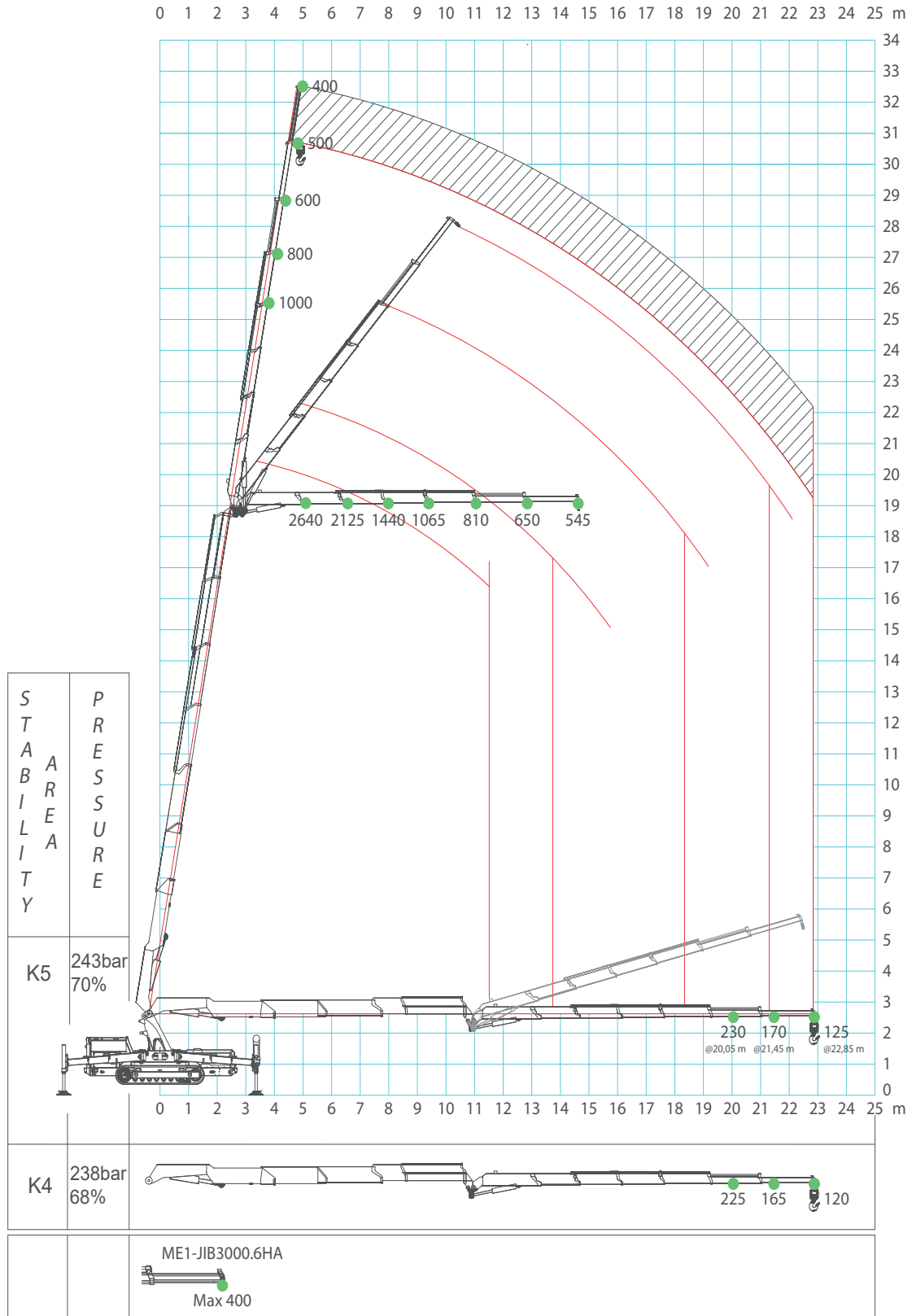

JF545 - JIB3000.6HA

W2000-JFM and FULL COUNTERWEIGHT installed

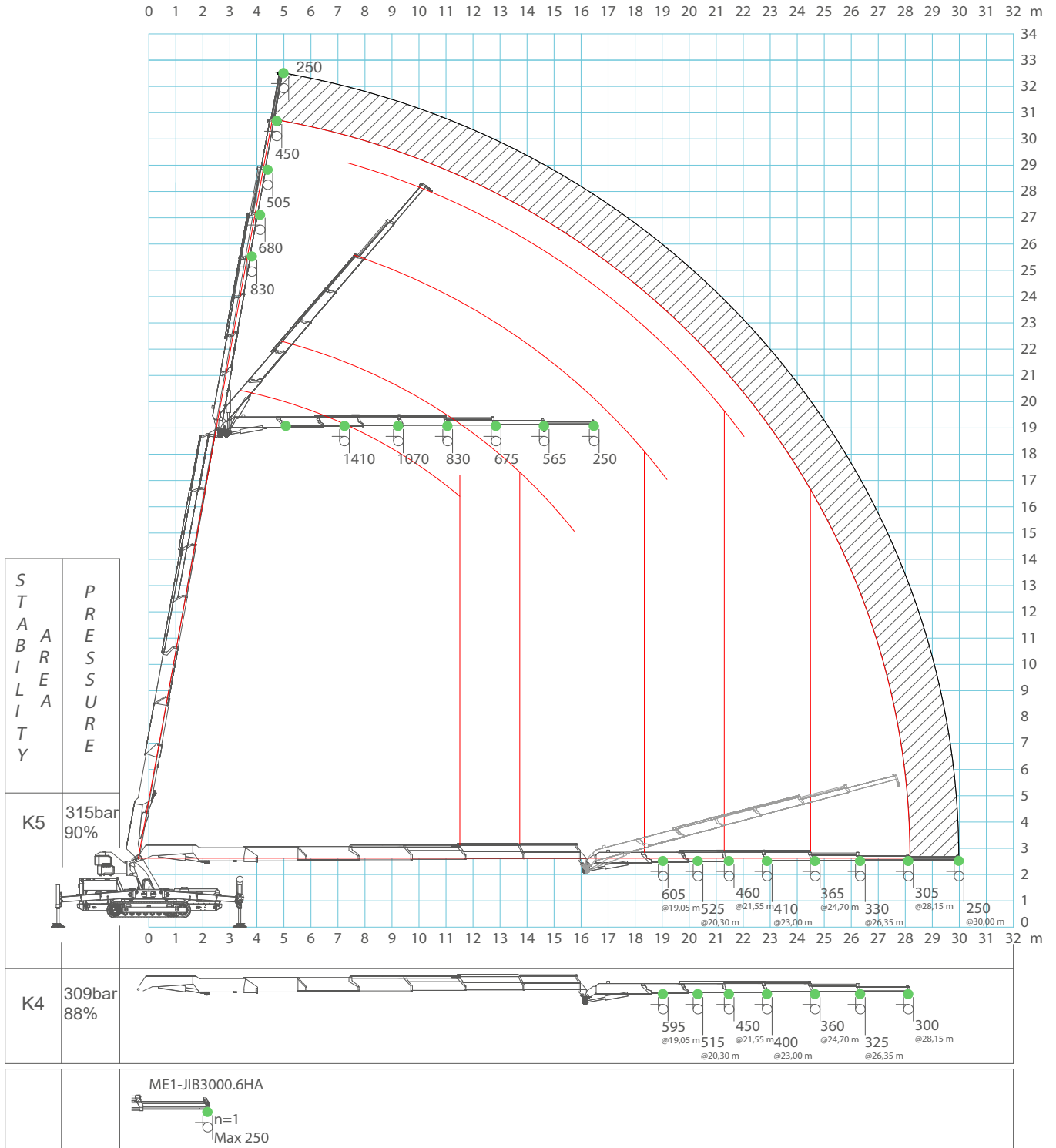

JF545 - JIB3000.6HA

W2000-JFM and NO COUNTERWEIGHT installed

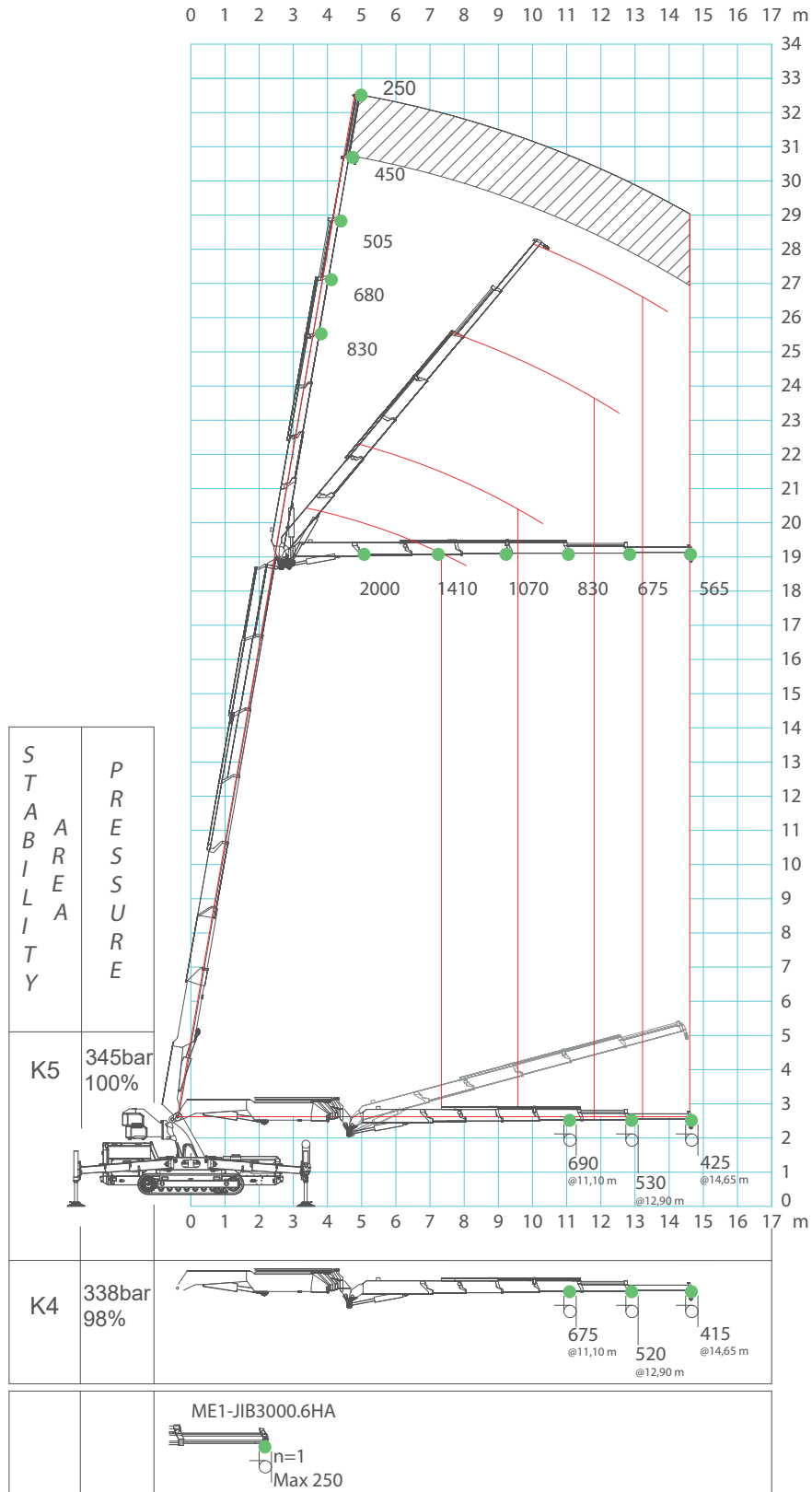

JF545 - STATIC/DYNAMIC LIFTING CAPACITY

W2000-JFM and FULL COUNTERWEIGHT installed

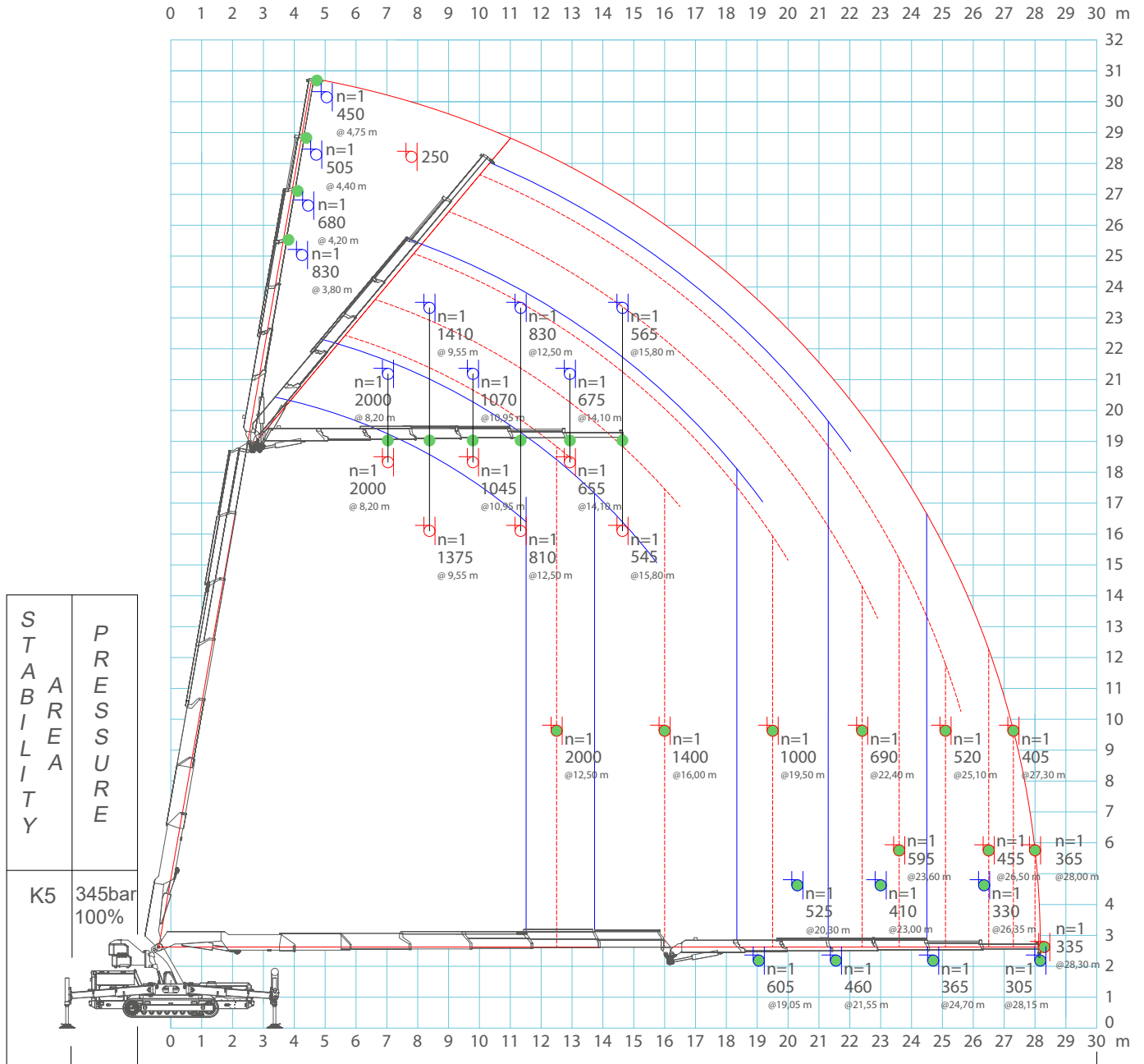

- - - - - Static lifting capacity: LMI stop position.
- — — — — Dynamic lifting capacity: all crane function are possible.

JF545 - MWP-1PG.JIB3000.6H

Man Working Platform for 1 Worker

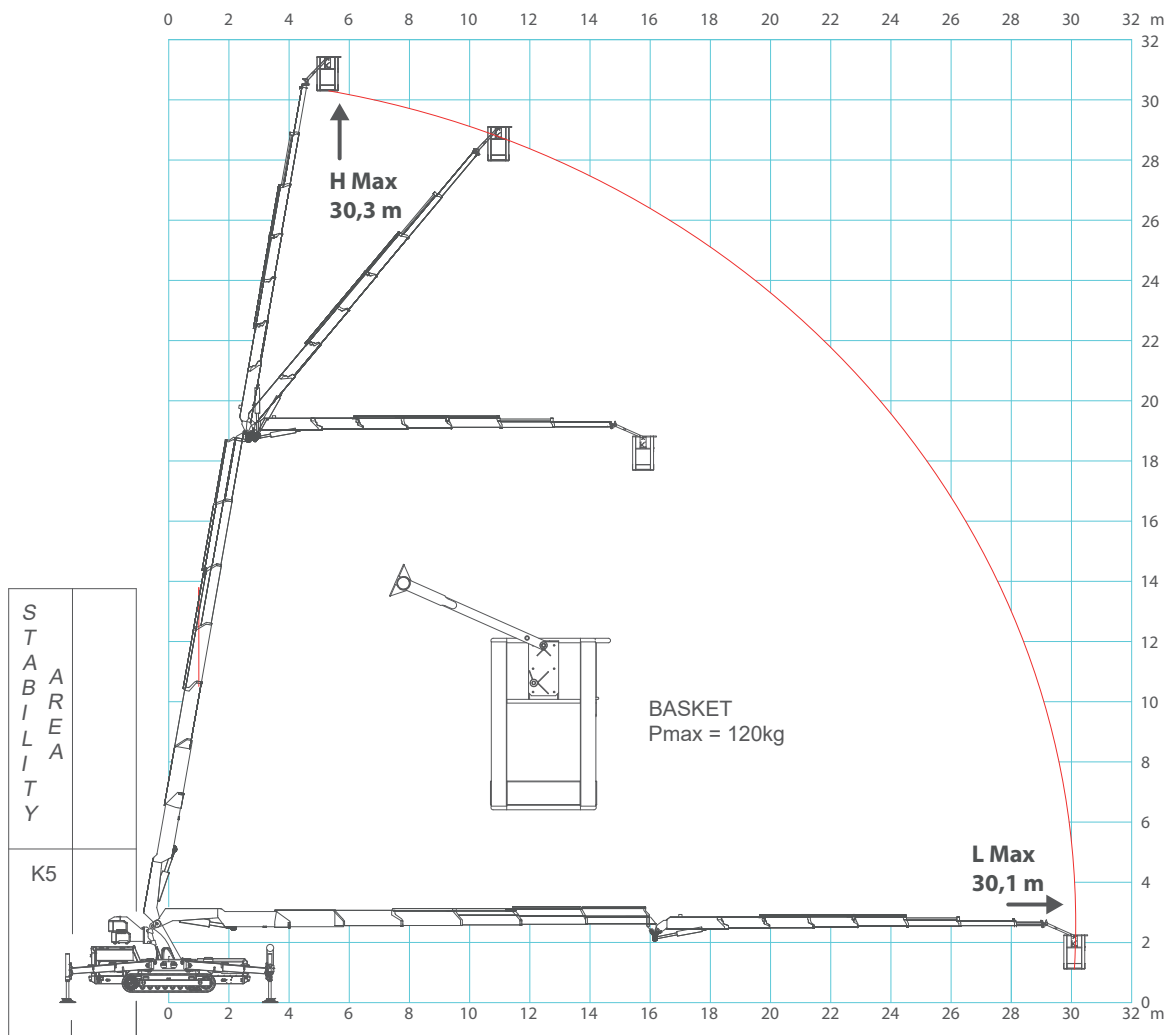

JF545 - MWP-2PG.JIB3000.6H

Man Working Platform for 2 Workers

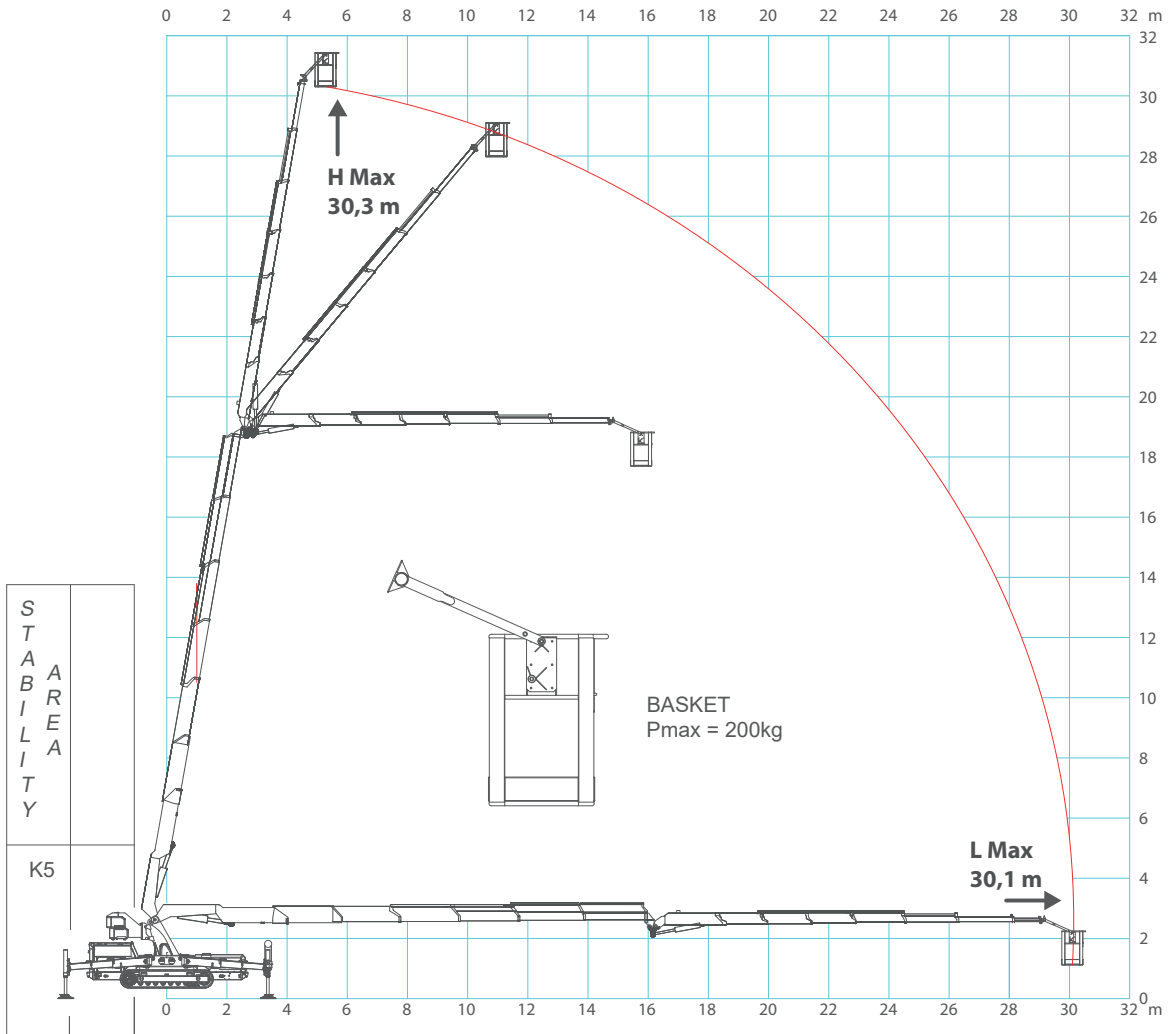

JF545 - MWP-2PGR.JIB3000.6H

Rotating Man Working Platform for 2 Workers

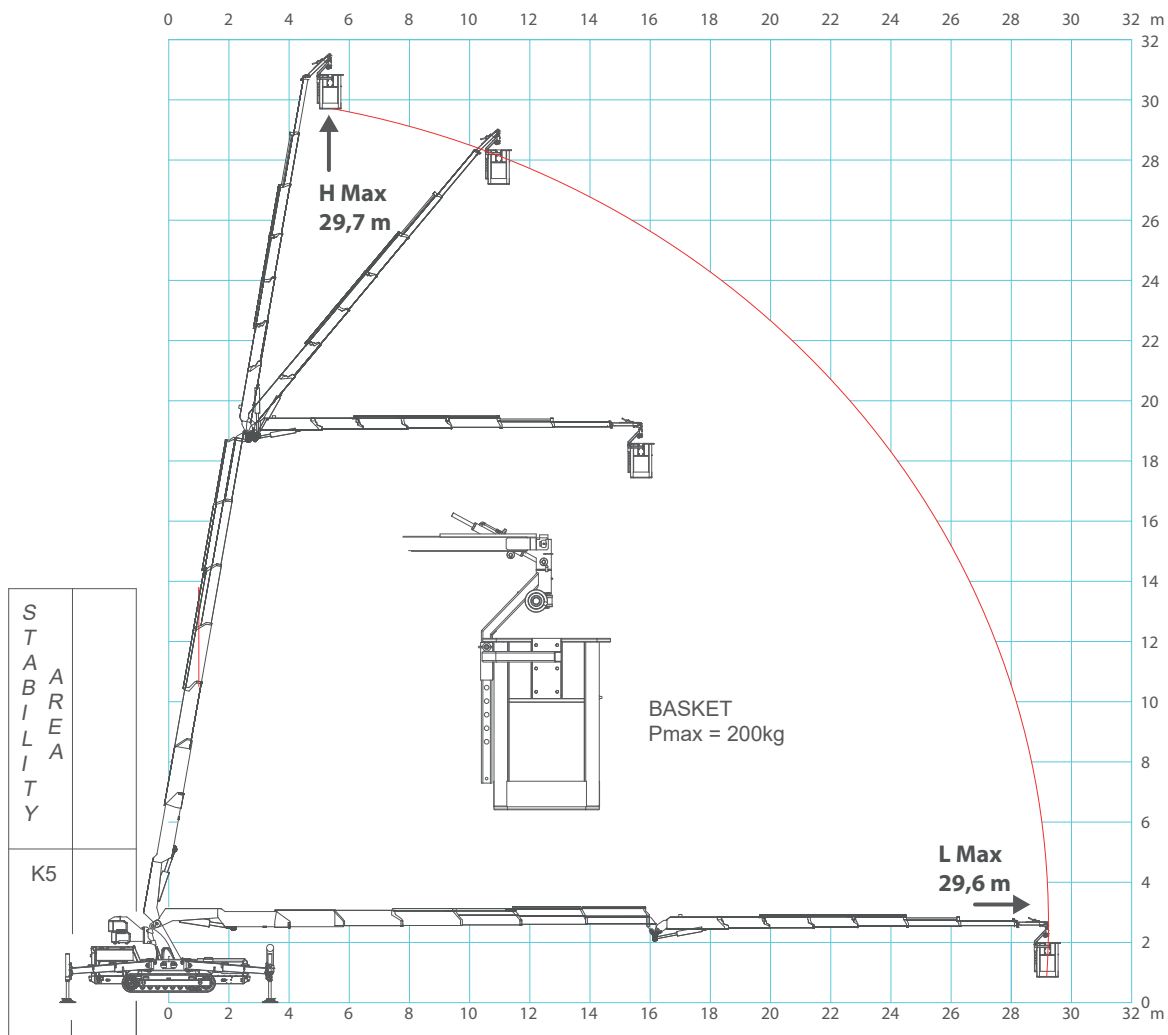

PLE STABILITY CONDITION

Maximum stability needs 8 conditions: 4 complete outriggers rotation and 4 complete outriggers extension. Every lack of condition induces a loss of working area. If more than one condition lack inhibit sectors are added.

Outrigger rotation is considered at its maximum when angle is $<43^\circ$.

Outrigger extension is considered at its maximum when is greater than 95%.

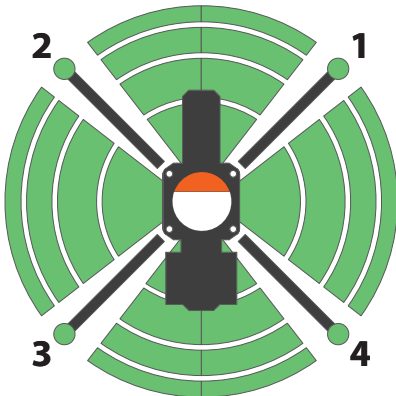

Maximum stability:
Full rotation of the outriggers.
Full extensions of the outriggers.



If even a single outriggers is not on the ground no possible movement is permitted.

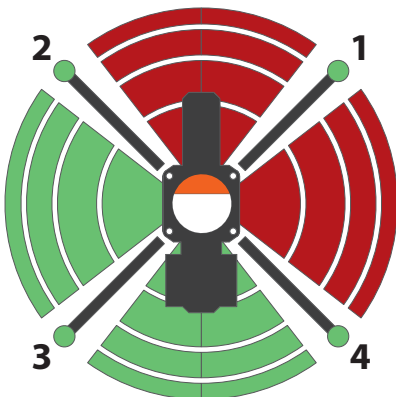

Outrigger 1 not fully extended but fully rotated.

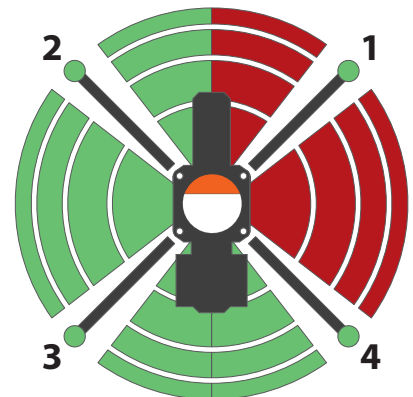

Outrigger 1 fully extended but not fully rotated.

ACCESSORIES JF545CDH

JFS4S

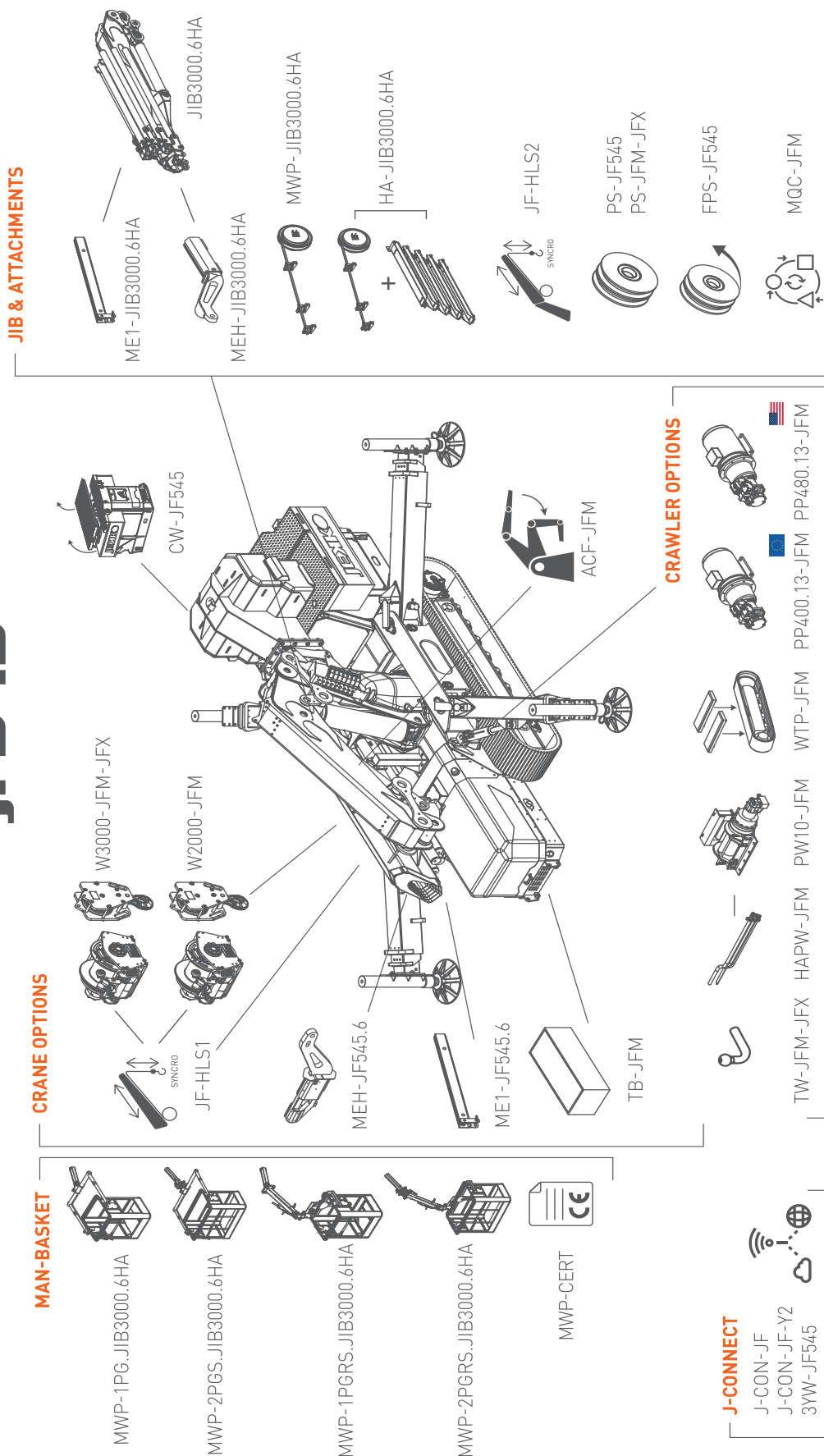

CRANE COLOR

Crane
Crawler & Frame
Carts & Tool Boxes

STANDARD

RAL2004
 RAL9005
 RAL9005

PC1

RAL
 RAL7021
 RAL7021

PC1+PC2

RAL
 RAL
 RAL

PC1+PC2+PC3

RAL
 RAL
 RAL



LAYOUT



ACCESSORIES FEATURES

MEH-JF545.6

MEH-JIB3000.6HA

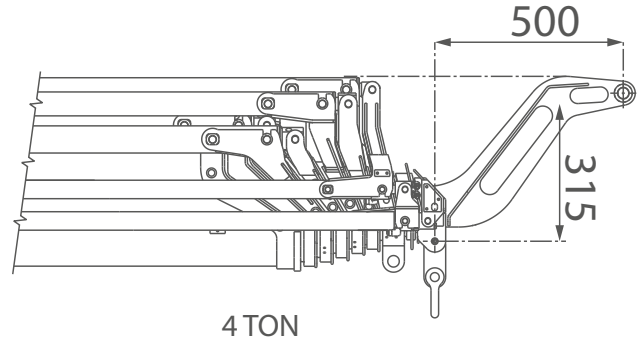
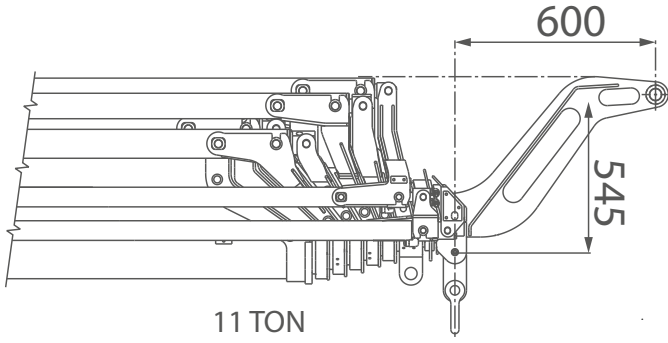

JIB3000.6HA

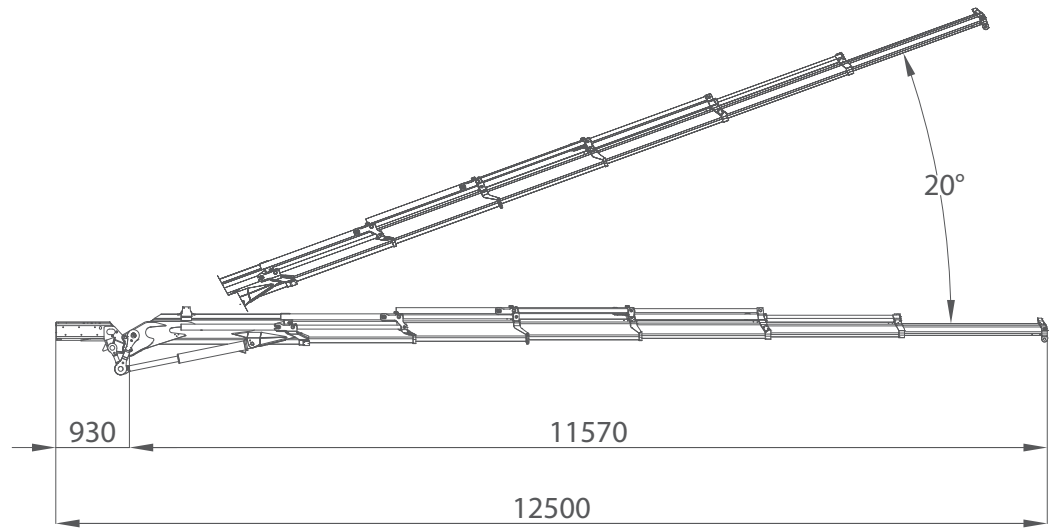
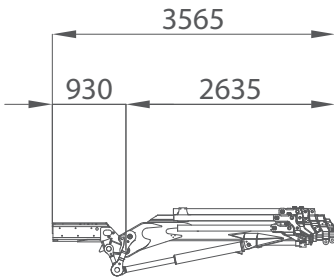

WTP-JFM

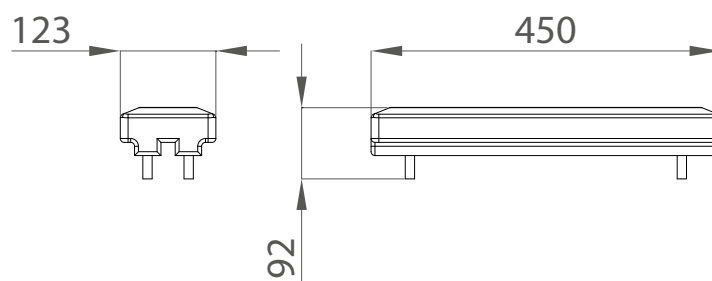

2MF-CL

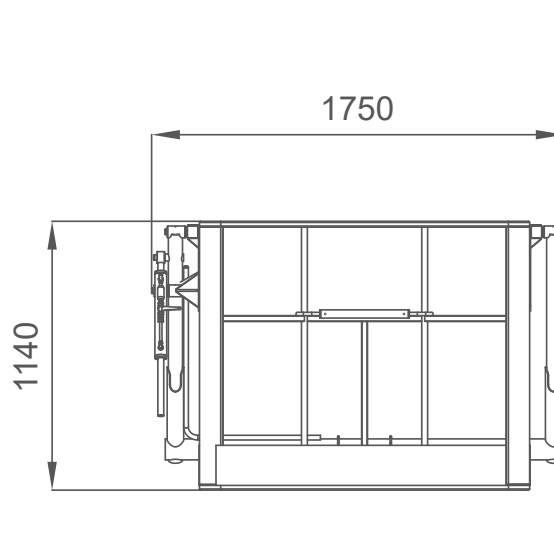



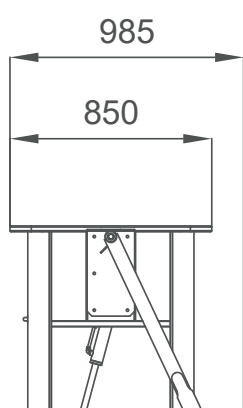



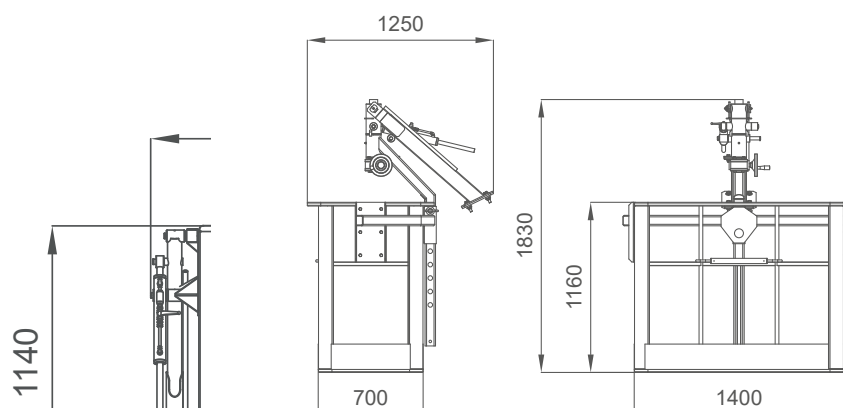













































1MF-CL



2MF-RCL



SYMBOLS

	Weight		Engine		Boom Angle		Minipicker
	Counterweight		Diesel Fuel		Boom Length		Back Wheel Loading Point
	Crane		Petrol Fuel		Boom Radius		Front Wheel Loading Point
	Dimensions		Tank		Jib on Board		Working Radius
	Stabilization Area		Power		Without Jib on Board		Stabilizing Bar
	Travel Speed		Battery		Jib Hook Radius		Standard
	Gradeability		Lithium Battery		Jib Length and Angle		Factory max. load
	Outrigger Load		Powerpack		Jib Length		Building site max. load
	Track Loading		Main Winch		Jib Radius		Maximum inclination of the machinery
	Outriggers Setup		Hookblock		Manipulator Length		Hydraulic oil
	Ext Tracks Width		Slewing		Manipulator Radius		Winter Warm-up Kit
	Chart on Tracks		Slewing Locked		Number of vacuum pads		Horizontal Boom Angle
	Slope		Outriggers mats		Grabber		White Pads for Steel Tracks

REMARKS REFERRING TO LOAD CHART

- HC1 HD5 S2 lifting class according to EN12999:2011 standards.
- Lifting capacities are given in kilograms.
- The weight of the hook blocks and hooks is part of the load and therefore it must be deducted from the lifting capacities.
- Working radii are measured from the slewing centre.
- The lifting capacities given for the telescopic boom apply if the folding jib is removed.
- Subject to modification of lifting capacities.

YOUR JEKKO DEALER

EN All specifications and features herein described can be changed without prior advice. All indicated data are indicative only and are not binding as crane performs differently depending on its use. **IT** Tutte le caratteristiche e le specifiche descritte possono essere soggette a variazioni senza preavviso. Tutti i dati riportati sono forniti a puro titolo informativo e non sono impegnativi dal momento che le prestazioni della macchina variano in funzione dell'utilizzo. **DE** Unangekündigte Änderungen sämtlicher Eigenschaften und Daten sind möglich. Alle Angaben sind Richtwerte und nicht verbindlich da die Leistungen der Vorrichtung von deren Einsatz abhängen. **ES** Todas las características y las especificaciones aquí indicadas pueden ser sujetas a variaciones sin aviso. Se dan todos los datos aquí indicados como simples informaciones. No se consideran como vinculantes, dado que las prestaciones del maquinario pueden variar. **FR** Toutes les caractéristiques et le spécifications descriptives peut être sujet à variation sans préavis. Tout les données rapportés sont fournis à titre informatif et ne sont pas engager au moment que la prestation de la machine change en fonction de l'emploi.



www.jekko-cranes.com

Visit jekko-cranes.com to keep in contact with us, discover all the latest news and find out technical details of all our products.

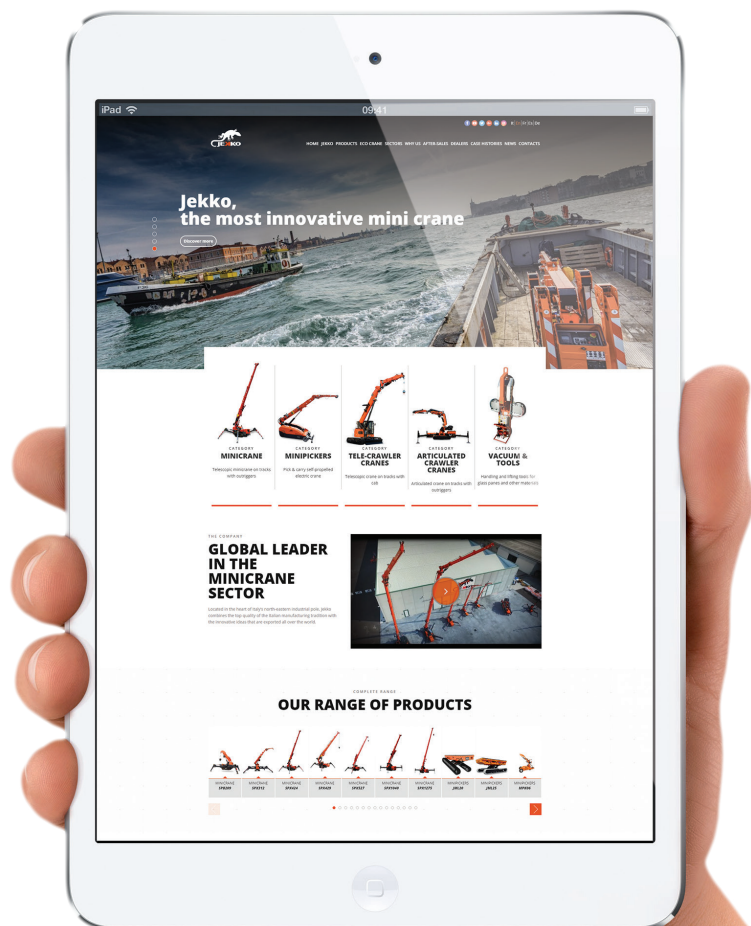



Jekko s.r.l.

Via Campardone, 1 - 31014 Colle Umberto (TV) - Italy
info@jekko.it - www.jekko-cranes.com

21.01.2022 | Rev.1.1

SERIAL NUMBER: